

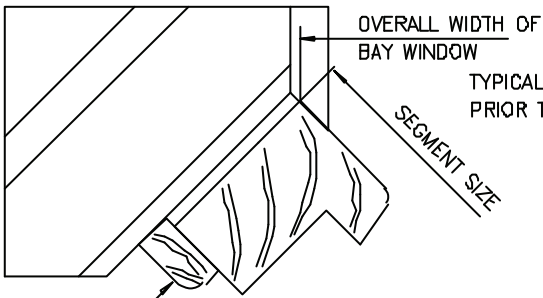

BAY WINDOW SURVEY DETAILS



TYPICAL BAY WINDOW EDGE CONDITIONS PRIOR TO REPLACEMENT

REFERENCE DIMENSIONS FOR BAY WINDOWS ALL DIMENSIONS ARE INTERNAL

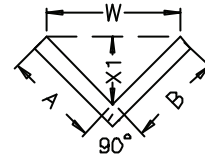

2 SIDED SQUARE BAY

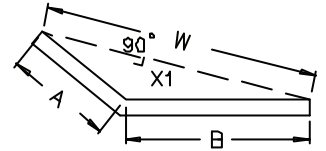

2 SIDED ANGLED BAY

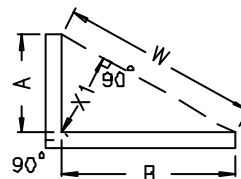
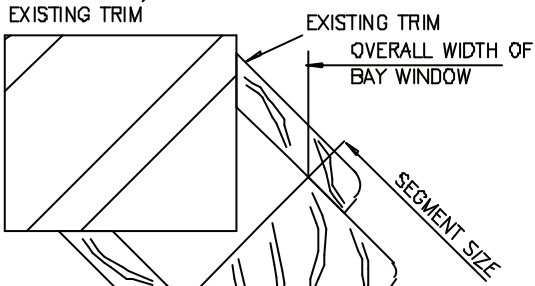

2 SIDED SQUARE BAY

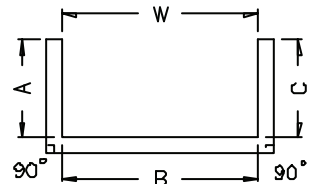

3 SIDED SQUARE BAY

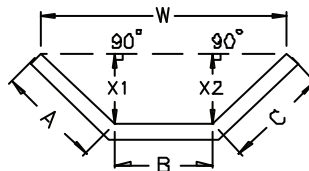
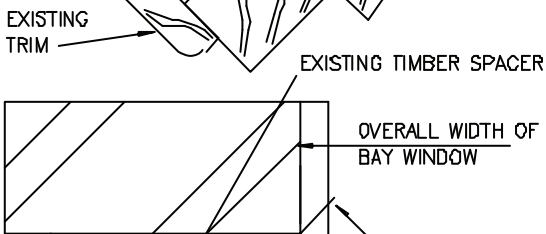

3 SIDED ANGLED BAY

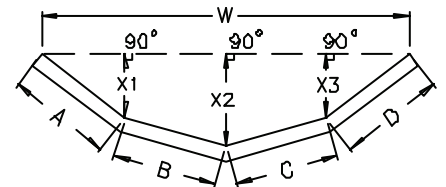

4 SIDED ANGLED BAY

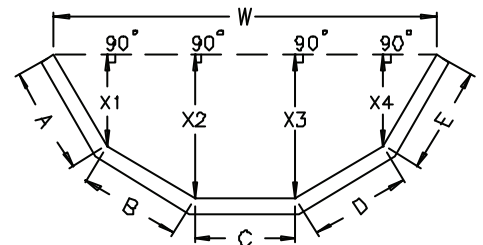

5 SIDED ANGLED BAY

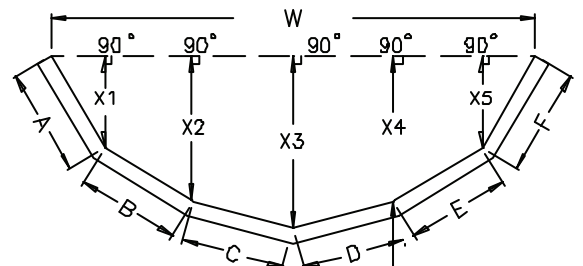
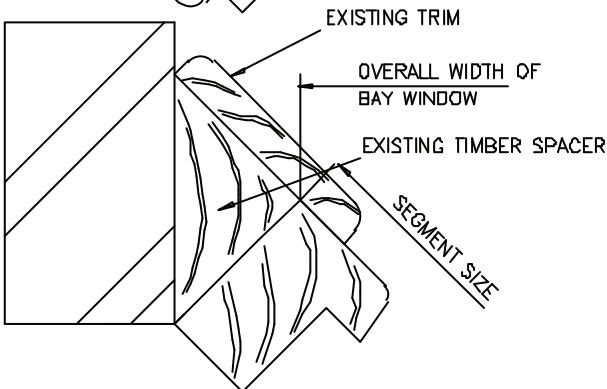

6 SIDED ANGLED BAY

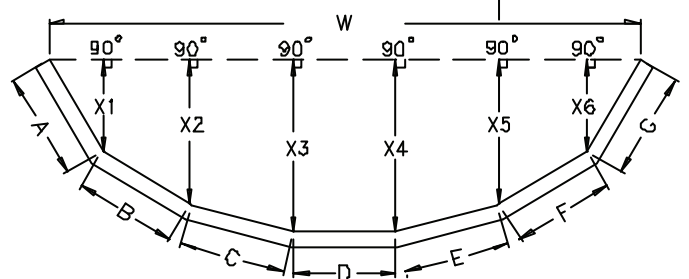
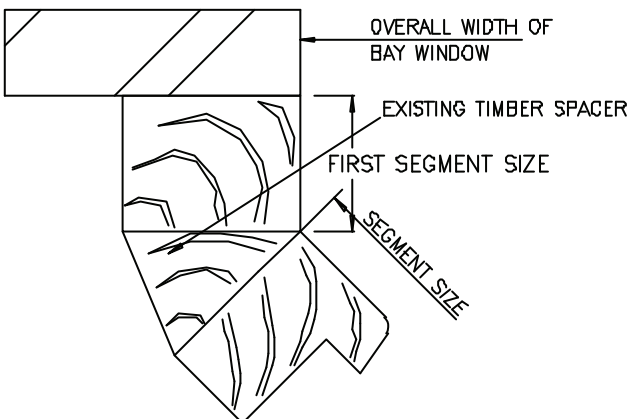

7 SIDED ANGLED BAY